

# Application Guidelines

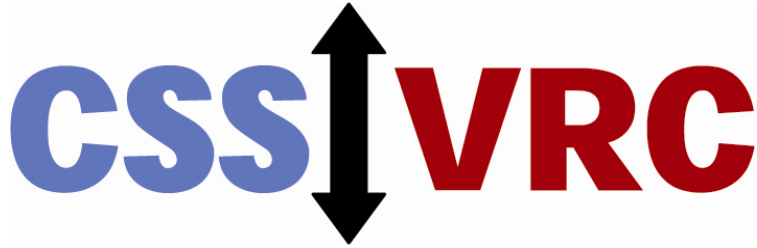

## Vertical Reciprocating Conveyors

As referenced by ASME B20.1 for use in conjunction with that standard

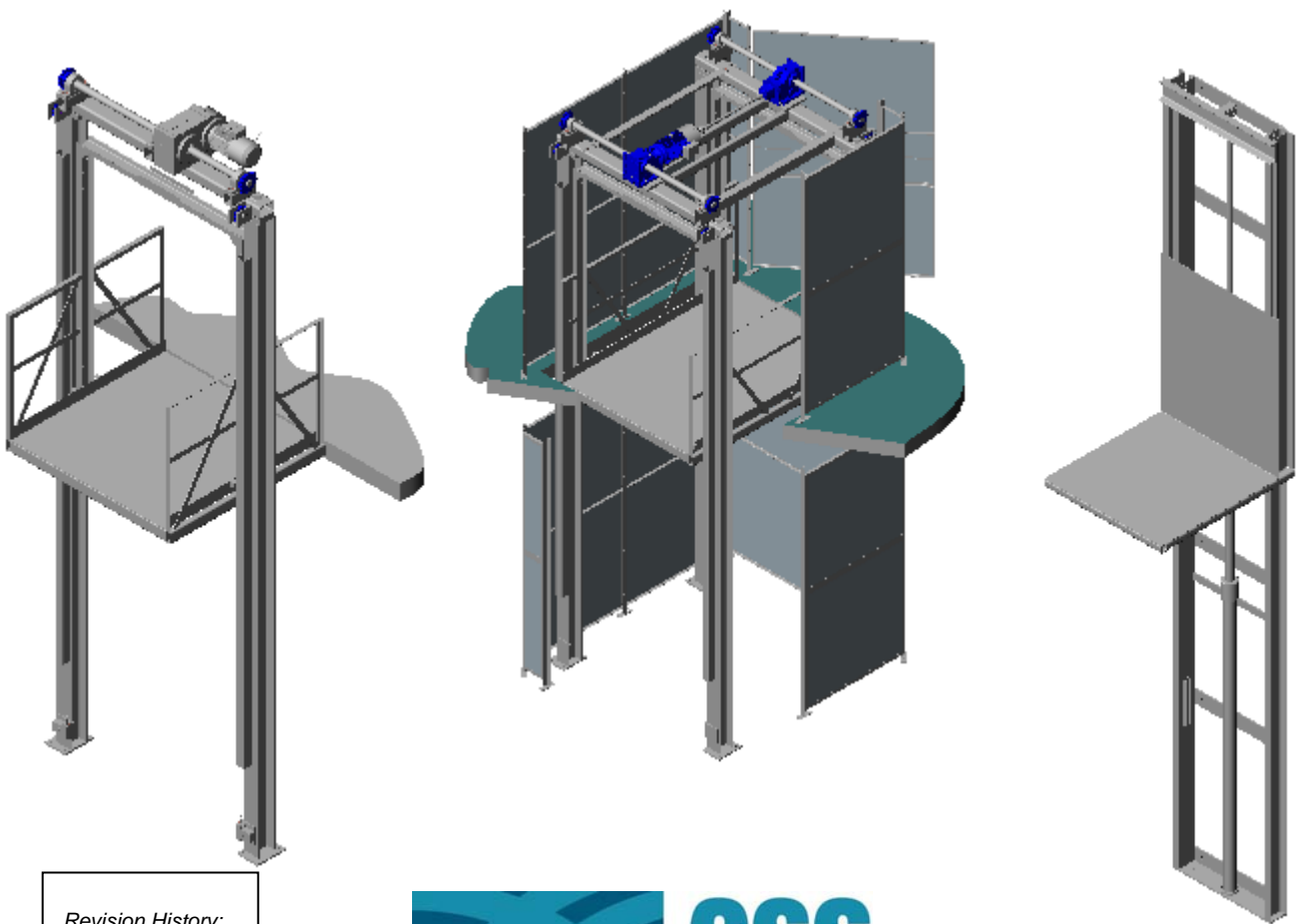

*Revision History:*  
May 31, 2001  
April 2003  
June 2004  
September 2007  
October 2009  
February 2010



Copyright 2010

Duplication allowed, but no alterations may be made to content.

# Table of Contents

<b>Introduction</b> .....	<b>4</b>
<b>Foreword</b> .....	<b>6</b>
<b>1 – Scope and Purpose</b> .....	<b>8</b>
1.1 – Equipment Covered .....	8
1.2 – Equipment Not Covered.....	8
1.3 – Purpose.....	8
1.4 – Potential Applicable Codes .....	9
<b>2 – Terms &amp; Definitions</b> .....	<b>10</b>
<b>3 – Applications</b> .....	<b>16</b>
3.1 – Areas of Use .....	16
3.2 – Types of Use .....	17
<b>4 – VRC Types &amp; Configurations</b> .....	<b>17</b>
4.1 – Straddle Design.....	17
4.2 – Cantilever Design.....	17
4.3 – Four Post Design .....	18
4.4 – Double Mast Design.....	18
<b>5 – Specification Considerations</b> .....	<b>20</b>
5.1 – Travel .....	20
5.2 – Floor-to-Floor Distance .....	20
5.3 – Capacity, Size and Type of Load .....	20
5.4 – Orientation of Loads.....	20
5.5 – Loading and Unloading Methods .....	21
5.6 – Platform Guarding and Accessories.....	22
5.7 – Electrical Considerations and Areas of Use.....	23
5.8 – Operational Considerations.....	23
5.9 – Power Units and Drive Types.....	23
<b>6 – Installation Considerations</b> .....	<b>25</b>
6.1 – Installer Guidelines.....	25
6.2 – Surface Mounted Lifts .....	29
6.3 – Pit Mounted Lifts .....	31
6.4 – Mast or Guide Beam Support.....	31
6.5 – Floor Opening and Mezzanines .....	32
<b>7 – Electrical Considerations</b> .....	<b>33</b>
<b>8 – Wiring Considerations</b> .....	<b>33</b>
<b>9 – Power Unit Considerations</b> .....	<b>33</b>

<b>10 – Safety Gate and Enclosure Considerations .....</b>	<b>34</b>
10.1 – Basic Requirements .....	34
10.2 – Safety Gate Types .....	34
10.3 – Gate Interlocks – General .....	38
10.4 – Back Stop Panel.....	39
<b>11 – Labeling .....</b>	<b>40</b>
11.1 – Minimum Recommended Labels.....	40
<b>12 – Maintenance Considerations .....</b>	<b>46</b>
12.1 – Safe Blocking Instructions.....	46
12.2 – Achieving Maintenance Position .....	46
12.3 – Placement of Maintenance Devices.....	47
12.4 – Blocking the Carriage.....	47
12.5 – Electrical Safety .....	48
12.6 – Specific to Mechanical Lifts.....	48
12.7 – Specific to Hydraulic Lifts .....	48
12.8 – General Maintenance.....	48
12.9 – Hydraulically Actuated VRC .....	49
12.10 – Mechanically Actuated VRC.....	49
12.11 – VRC Lift System.....	49
12.12 – VRC Guide System.....	50
12.13 – VRC Safety Devices.....	50
<b>13 – Operation Considerations .....</b>	<b>51</b>
<b>14 – Start-up Testing.....</b>	<b>52</b>

## Introduction

An Industry Position on the Definition and Regulation of Vertical Reciprocating Conveyors (VRCs)

### Purpose

It is the intent of the VRC Subcommittee of the Conveyor and Sortation Systems Product Section of the Material Handling Industry of America to place into the hands of VRC equipment suppliers, installers, end users, inspectors and any other Authority Having Jurisdiction (AHJ) a clear and definitive argument as to the validity of applying only ASME B20.1 to Vertical Reciprocating Conveyors.

### Background

At the center of the controversy and confusion are two types of elevating platforms that are governed by two separate industry safety codes: Material Lift Type A as defined and governed by ASME A17.1 – *Safety Code for Elevators and Escalators*, and VRCs as governed by ASME B20.1 – *Safety Standard for Conveyors & Related Equipment*.

Material Lift Type A is defined in A17.1 as: *“a hoisting and lowering mechanism normally classified as an elevator . . . serving two or more landings for the purpose of transporting material. On Type A material lifts no persons are permitted to ride”*.

This definition has caused some confusion for VRC inspectors, many of whom are elevator inspectors well acquainted with the A17.1 code, but who have limited exposure to the B20.1 code and the equipment it governs (namely, VRCs). Consequently, this confusion has led to a growing number of cases where VRCs have been incorrectly considered to be A17.1 Material Lifts.

### Material Lift Elevators vs. VRCs – a Comparative Approach

It seems that the ability to distinguish a VRC from a Material Lift Elevator is imperative when deciding which safety code to apply. Here is a general comparison between the two when making that distinction:

#### 1. Manufacturer’s Intent

The manufacturer of the equipment can tell you what safety code the equipment is designed and manufactured to meet.

Material Lifts are simply elevators (passenger or freight) which have been altered and/or re-classified to carry material only, and are therefore manufactured to meet the Safety Standards of ASME A17.1.

VRCs are designed solely to transport material and equipment and are therefore manufactured to satisfy the less stringent and costly industrial standards of ASME B20.1. In fact, the A17 code specifically and expressly excludes all B20 conveyors – which include VRCs – from the scope of equipment intended to be covered by that code (section 1.1.2(g)).

## 2. People Exposure

Material Lift Elevators are designed and manufactured to convey people, with or without material, in a people-exposed environment.

VRCs are designed and manufactured to convey material or equipment only in a commercial or industrial environment.

## 3. Shaftways

Material Lift Elevators must operate within a hoistway or shaftway.

VRCs may operate within a hoistway or shaftway.

## 4. Operating Speed

Material Lift Elevators operate with speeds normally above 100 feet per minute, often with elevator speed controls.

VRCs operate with speeds normally below 100 feet per minute.

## 5. Platform Guides

Material Lift Elevators must be guided by T-style elevator guides attached to the carriage along T-style fixed elevator rails attached to the building structure.

VRCs platforms are normally guided with rollers within guide columns braced to the building structure.

## 6. Controls

Material Lift Elevator operator controls may be accessed from the lift platform.

VRC operator controls are never accessible from the lift platform.

## 7. Door Safeties

Material Lift Elevators require ASME A17 approved door interlocks at all landing doors.

VRCs require a combination mechanical lock and electric door status switch on all landing doors.

## 8. Authority Having Jurisdiction

Material Lift Elevators are typically regulated and inspected by a state or municipal authority.

VRCs are typically regulated and inspected by OSHA.

## Conclusion

Material Lift Elevators are a distinct and separate form of conveyance than Vertical Reciprocating Conveyors, therefore it is necessary to apply separate and appropriate codes to each. There is no authority which supports the application of ASME A17.1 Material Lift requirements to VRCs, and to do so is not only a misinterpretation of the code itself, but imposes unreasonable requirements on, creates unnecessary regulatory and administrative obstructions for, and places an additional financial burden on the end user of the equipment.

The only valid safety code which can be used to regulate VRCs is ASME B20.1.

## **Foreword: Application Guidelines for Vertical Reciprocating Conveyors**

The Vertical Reciprocating Conveyor Sub-Committee is a group of VRC manufacturers which comprise a substantial portion of the major companies that design and manufacture VRCs in the United States. This group functions within the Conveyor and Sortation Systems (CSS) Product Section of Material Handling Industry of America (MHIA). This most current edition of *Application Guidelines for Vertical Reciprocating Conveyors* is a result a consensus among these manufactures that the descriptions, specifications and guidelines contained herein represents the industry's best practices. This guideline represents recommended safety practices for VRCs and it was developed to offer specific, detailed information to parties engaged in the manufacture, marketing, purchase, inspection or use of VRCs.

By way of background, the lack of detailed and specific design standards for VRCs sometimes caused confusion with manufacturers, users and various governing bodies who, because of the lack of detailed standards, apply existing standards of non-related lifting, hoisting or elevating equipment to VRCs.

The *Application Guidelines for Vertical Reciprocating Conveyors* was thoroughly revised and republished from its original 1991 version as a result of the VRC manufacturers' recognition of the need to develop a comprehensive safety guideline and establish minimum design criteria when used in conjunction with ASME B20.1. - The Safety Standard for Conveyors and Related Equipment. As a performance standard ASME B20.1 defines the end performance, but does not detail how to accomplish that result. This publication details how the industry ensures the safe application and utilization for the protection of users and operators of today's various developed VRC designs.

At the date of the creation of this guideline the Vertical Reciprocating Conveyor Sub-Committee consisted of the following member companies:

Autoquip Corporation  
Pflow Industries, Inc.  
Southworth International Group, Inc.  
United Sortation Solutions  
Wildeck, Inc.

Suggestions for improvement of this guideline are welcomed. They should be sent to the Conveyor and Sortation Systems Product Section of Material Handling Industry of America, 8720 Red Oak Boulevard, Suite 201, Charlotte, NC 28217-3992.

## Disclaimer

Material handling industry (MHI), CSS and VRC, and their members assume no responsibility and disclaim all liability of any kind, however arising, as a result of acceptance or use or alleged use of these guidelines. User specifically understands and agrees that MHI and CSS and VRC and their officers, agents, and employees shall not be liable under any legal theory of any kind for any action or failure to act with respect to the design, erection, installation, manufacture, preparation for sale, sale, characteristics, features, or delivery of anything covered by these guidelines. Any use of this information must be determined by the user to be in accordance with applicable federal, state and local laws and regulations.

MHI and CSS and VRC make no warranties of any kind, express, implied or statutory, in connection with the information in these guidelines. MHI and CSS and VRC specifically disclaim all implied warranties of merchantability or of fitness for particular purpose.

By referring to or otherwise employing these guidelines, the user agrees to defend, protect, indemnify, and hold MHI and CSS and VRC and their officers, agents, and employees harmless from and against all claims, losses, expenses, damages, and liabilities, direct, incidental, or consequential, arising from acceptance or use or alleged use of this standard, including loss of profits and reasonable attorneys' fees which may arise out of the acceptance or use or alleged use of these guidelines. The intent of this provision and of the user is to absolve and protect MHI and CSS and VRC and their officers, agents, and employees from any and all loss relating in any way to these guidelines, including those resulting from the user's own negligence.

Suggestions with respect to these Guidelines are welcomed.

They should be sent to:

Conveyor and Sortation Systems  
Material Handling Industry of America  
8720 Red Oak Boulevard  
Suite 201  
Charlotte, NC 28217-3992

Copies of this document, in its entirety, may be freely used, distributed or promulgated electronically. The Application Guidelines for Vertical Reciprocating Conveyors is copyrighted for the purpose of maintaining the complete document, without changes or alterations.

# **1 Scope and Purpose**

## **1.1 Equipment Covered**

This Application Guideline is intended to specifically apply to Vertical Reciprocating Conveyors (VRC) which are designed to raise and lower materials from one elevation to another. They are primarily hydraulically or electro-mechanically activated and powered. VRCs are mounted in a stationary position. The equipment may perform a stand-alone function or may be incorporated into an automated system. Equipment covered by this Application Guideline falls under ASME/ANSI B20.1-Safety Standard for Conveyors and Related Equipment.

## **1.2 Equipment Not Covered**

This Application Guideline does not relate to:

- Aerial work platforms used for building maintenance and construction purposes such as covered by ANSI/SIA A92
- Elevators and equipment of any type as covered in ANSI/ASME A17.1
- Industrial scissors lifts as covered in ANSI MH29.1
- Any portable lifts not permanently attached to a building structure
- Any lift designed to transport personnel
- Lifts for handicapped access as described by ANSI/ASME A18
- Inclined conveyors

## **1.3 Purpose**

The purpose of this Application Guideline is to provide designers, sellers, installers, inspectors, owners, users and governing bodies with a source of information for consideration in design, application, configuration criteria as well as recommended minimum requirements for design, specification and labeling.

## **1.4 Potential Applicable Codes**

**1.4.1** ASME B20.1 Safety Standard for Conveyors and Related Equipment

**1.4.2** International Building Code (IBC)

Recent adoption of the international building code (IBC) by many state and local building officials has included – by reference in chapter 30 of the IBC – the recognition of VRCs and their jurisdiction under ASME B20.1. Be aware that special permitting and testing of your VRC may be required by state or local building code officials to provide building inspectors a means to verify the compliance of the equipment with the general safety requirements set forth in ASME B20.1. It is ultimately the responsibility of the customer to verify the need for, and assume the added costs of, any such special permitting and/or testing.

**1.4.3** Fire Underwriters

**1.4.4** National Electric Code

**1.4.5** ANSI Z535.4 Product Safety Sign and Label

## **2 Terms & Definitions**

### **2.1 Approach Ramp**

An access ramp used to load on/off of a platform.

### **2.2 Authorized Person**

Trained or qualified personnel approved or assigned to perform a specific duty or duties.

### **2.3 Back Frame**

The vertical portions of the carriage on a cantilever VRC.

### **2.4 Back Stop Panel**

Panel that is installed opposite the loading edge at upper loading levels of a VRC platform, to prevent personnel and/or the load from falling to the lower level. This term should not be confused with the term “backstop” as defined in ANSI/ASME B20.1

### **2.5 Cable**

Wire rope.

### **2.6 Cantilever**

A style of VRC where the carriage rides along masts that are located on the same side of the carriage. This style lift can accommodate “C”, “Z” and 90 degree loading patterns.

### **2.7 Capacity**

The maximum load for which the VRC is designed.

### **2.8 Carriage or Carrier**

The entire structural assembly that travels on the mast and carries the load.

### **2.9 Constant Pressure Push Button**

A push button, which to activate, must remain pressed by the operator in order to perform a desired operation.

## **2.10 Controls**

Any electrical device used in the operation or control of a lift. Normally includes push button stations, control box, limit switches, interlocks, etc.

## **2.11 Control Voltage**

The secondary voltage, which typically originates at a transformer and provides power to the control devices.

## **2.12 Conveyor, Vertical Reciprocating**

A reciprocating power or gravity actuated lifting device (not designed to carry passengers or an operator) that receives objects on a carriage and transports these objects vertically from one elevation to another.

## **2.13 Cylinder**

A device, which converts fluid power into linear force and motion. It usually consists of a movable element such as a piston and piston rod, plunger or ram, operating within a cylindrical bore.

## **2.14 Direct acting cylinder**

The cylinder or ram transmits lifting force directly to the carriage rather than through the use of cables, sheaves or chains.

## **2.15 Drift**

The distance a lift platform will slowly drop due, usually, to slight internal leaks in a hydraulic system or mechanical slippage of a motor brake.

## **2.16 Enclosure (lift guarding)**

Structure surrounding a VRC to prevent outside interference with its normal operation and to safe guard personnel. Typically 8' high panels composed of expanded metal or other materials that will prevent a 2" diameter ball from passing through. This is a requirement of ASME/ANSI-B20.1.

## **2.17 Explosion Proof**

Electrical devices that are designed to operate safely in a specific location or area where potentially explosive environments can or do exist.

## **2.18 Gate**

A device that opens and closes manually or automatically to allow access to the carriage for loading and unloading. It is normally a swing, sliding, or vertical acting device constructed of similar expanded metal as the enclosure.

## **2.19 Guarded by Location**

Describes moving parts so protected by their remoteness from the floor, platform, walkway, or other working level, or by their location with reference to frame, foundation, or structure as to reduce the foreseeable risk of accidental contact by persons or objects. Remoteness from foreseeable, regular, or frequent presence of public or employed personnel may in reasonable circumstances constitute guarding by location.

## **2.20 Interlock (Gate/Door)**

A locking system used on the access doors or gates of a VRC to prevent its operation unless all such doors/gates are closed and to prevent the opening of any such gate/door unless the VRC carrier or carriage is present at that particular landing or opening.

## **2.21 Intermediate Stop**

Usually a stop between top and bottom floors or levels.

## **2.22 Landing**

A permanent-working surface at a fixed elevation used for loading/unloading a lifting device.

## **2.23 Limit Switch**

An electrical control device by which the position or movement of the lift may be controlled within predetermined limits.

## **2.24 Load Height**

The maximum height of material for which the VRC has been designed.

## **2.25 Load Pattern**

A method to describe the direction a load will be moved on and off a platform at different landings or levels.

**2.26 Mast(s) or Guide Beams**

The vertical members by which the carriage is guided throughout its vertical travel.

**2.27 Mechanical Stop**

A mechanical means of stopping travel at a predetermined position.

**2.28 Momentary Contact Push Button**

A push button, which only has to be pressed for an instant to activate the desired operation.

**2.29 Non-operating End**

The side(s) of a carriage or carrier not used for loading/unloading. Handrails with midrail and kickplate are normally supplied as minimum guarding.

**2.30 Operating End**

The side(s) of the platform used for loading/unloading. The side(s) is normally equipped with a safety chain as minimum guarding.

**2.31 Platform**

The horizontal floor surface of the carriage or carrier where the load is placed.

**2.32 Pressure Switch**

A pressure sensing switch that can be set to trip at a predetermined pressure. When this pressure setting is reached it will activate, thus providing a signal to the control circuit and stopping the pump motor.

**2.33 Primary Voltage**

The main electrical power being supplied for operation of the equipment.

**2.34 Push Button Station**

The wall mounted or hand held device used to control the operation of the equipment.

### **2.35 Qualified Person**

A person, who by possession of a recognized degree, certificate, professional standing, or skill, and who by knowledge, training and experience, has demonstrated the ability to deal with problems relating to the subject matter, the work, or the project.

### **2.36 Roll off Panel**

A structure used on upper levels to prevent personnel and/or products from falling off the platform when loading or unloading.

### **2.37 Sheave**

Device (pulley) which is designed to guide or change the direction of a wire rope or cable.

### **2.38 Slack Chain Device**

Device used to signal, interrupt power or alert of slack chain condition.

### **2.39 Spliced Carriage**

Carriage that is split or in several pieces and will be field assembled. This design facilitates ease of installation and handling.

### **2.40 Spliced Mast or Guide Beam**

Mast or Guide Beam fabricated and delivered in two or more sections necessitated by manufacturing, handling, or installation constraints.

### **2.41 Straddle**

A style of VRC where the carriage rides suspended between two masts that are located on opposite sides of the carriage. This style of lift will accommodate “C” and “Z” type loading patterns.

### **2.42 Velocity Fuse**

A hydraulic valve, which in the event of a severed hose, will lock the oil in the cylinder and prevent the cylinder from descending.

### **2.43 VRC**

Abbreviation for Vertical Reciprocating Conveyor.

## **3 Applications**

### **3.1 Areas of Use**

#### **3.1.1 Mezzanines**

With the increased usage of vertical space in buildings today, vertical conveyors are an excellent choice for moving materials from first floor level to the mezzanine level. VRCs may be installed either along the edge of a mezzanine or through a hole cut in the mezzanine floor depending on the user's preference and the handling requirements. This precludes the need to wait for, and tie up, expensive portable equipment for placing materials directly on the mezzanine or in a staging area.

#### **3.1.2 Multi-floor Buildings**

With the increased costs of land and building construction, new companies for their start-up expansion are utilizing older buildings. The use of a VRC can streamline a manufacturing or warehousing operation in this type of facility and make it a less expensive, productive facility. The addition of a VRC can relieve the burden of moving materials and cargo on an existing elevator thus freeing up the elevator for the purpose it was intended, moving people. The VRC can also be strategically located within the building to provide vertical transportation of goods or materials within close proximity of the production or storage area or it can be installed on the outside wall of the building if space is not available inside.

#### **3.1.3 Existing Shaft**

A VRC may be installed in an existing shaft if the application requires moving only goods or materials and not personnel.

#### **3.1.4 Automated Systems**

The platform of a VRC may be equipped with a powered roller conveyor assembly, a gravity conveyor with a drop lock assembly, a chain transfer conveyor assembly, a turntable device and/or a pusher assembly and can interface with conveyor lines, single or multi-level rack system, or a transport. The controls can be so designed such that the carriage or carrier can receive the load automatically, deliver products to a pre-selected destination and then return to its original position automatically.

## **3.2 Types of Use**

- 3.2.1 Manual loading** and unloading of boxes, cartons, and various other materials.
- 3.2.2 Pallet loads** using pallet hand trucks, motorized pallet trucks, or forklift trucks. Note the VRCs capacity when loading and unloading with heavy loading devices. The VRC must be designed and installed to tolerate the load plus the loading device.
- 3.2.3 Four wheeled carts**, hand trucks, wheeled bin trucks, wheeled trash trucks, gondolas, etc.
- 3.2.4 Automated loading** with the use of gravity, chain transfer sections or powered conveyors, turntables, pushers, etc. for the handling of pallet or slip sheet loads into or out of storage facilities, multilevel small order picking operations, for ceiling level transportation of products from one facility to another, and various other applications where multilevel continual flow is required and minimum floor usage is a requirement.
- 3.2.5 The transfer of Automatic Guided Vehicles (AGV's)** from one floor level to another.

## 4 VRC Types and Configurations

### 4.1 Straddle Design

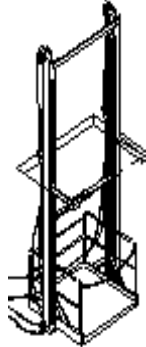

**4.1.1** This design type, as illustrated above, places the carriage between the guide beams and applies the load forces in the vertical direction along the length of the guide beams.

**4.1.2** This design allows for greater lifting capacities, larger platform sizes, and the ability to handle higher rollover forces created during loading and unloading. The method of loading and unloading and the resultant rollover forces must be specified by the owner and accommodated by the manufacturer when the equipment is designed and manufactured.

**4.1.3** A disadvantage of the straddle design is its limitation to loading and unloading from the two ends opposite each other.

### 4.2 Cantilever Design

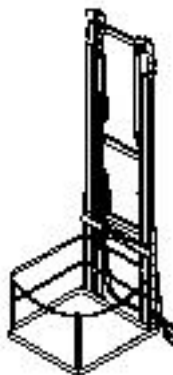

**4.2.1** **This type of VRC**, as mounted out in front of the guide beams.

**4.2.2** Four advantages of the cantilever design are: 1) the design allows access to three sides of the platform for loading and unloading, 2) the carriage overhead clearance may not be restricted by an overhead structural member as on a straddle design, 3) the overall height of the

unit may be less than for other designs, and 4) the footprint of the equipment may be reduced requiring less space for a given size carriage or carrier. These criteria may vary based on the particular application and should be reviewed on a case by case basis with the manufacturer.

- 4.2.3** Two disadvantages to this design are: 1) the loading creates an overturning moment on the guide structure which must be translated to the surrounding building or structure via bracing and 2) platform sizes and capacities may be limited due to the positioning of the load in relation to the guide structure.

### **4.3 Four Post Design**

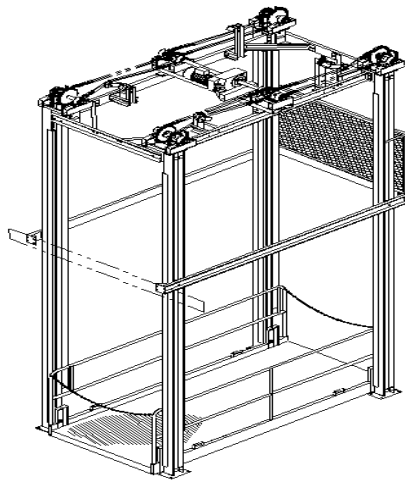

- 4.3.1** The VRC design as illustrated above has the platform mounted within the four guide beams. Bracing is recommended to handle the lateral loads imposed based on the particular application.
- 4.3.2** Three advantages of this design are 1) the opportunity to use very large platform sizes, 2) the ability to convey very high capacities, and 3) allows access from all four sides for loading and unloading.
- 4.3.3** A disadvantage to this design is a larger footprint.

### **4.4 Double Mast Design**

- 4.4.1** This design is similar to the four post in that it requires the use of four guide beams, but the difference is that the carriage or carrier is cantilevered between the two sets of masts and that the capacity and platform sizes are less when compared to the four post design.

**4.4.2** Two advantages of this design are 1) larger carriage or carrier sizes are allowable compared to the two post design, and 2) the overhead clearance of the load height is unhindered by structural cross members compared to the four post design.

**4.4.3** Two disadvantages of this design compared to the four post design are 1) loading is limited to the two ends and 2) platform sizes are not as large for a given capacity.

## **5 Specification Considerations**

### **5.1 Travel**

The difference in elevation between the top surface of the carriage or carrier at the bottommost level and the top surface of carrier or carriage at the uppermost level-regardless of whether the unit is pit or surface mounted.

### **5.2 Floor-to-Floor Distance**

The distance from one finished floor level to the next finished floor level.

### **5.3 Capacity, Size and Type of load**

Capacity not only refers to the weight of the load but also the physical size and configuration of the load. Types of loads are typically: individual boxes and items, palletized loads, drums, pushcarts, and trucks, etc. The platform should be sized to handle the largest loads with adequate clearances for handling operations. The capacity should take in consideration the weight of the equipment used for loading and unloading operations in addition to the weight of the heaviest load. If the loading and unloading process has the potential for intended or unintended imposition of large horizontal forces this must be taken into account during design.

### **5.4 Orientation of Loads**

The traffic pattern of the loads for loading and unloading will determine which style of VRC configuration can be used. There are 3 basic load traffic patterns. The most common is a “Z” pattern where the load is placed on one side of the platform at one level and removed from the opposite side at another level. The second most common traffic pattern is the 90-degree pattern where the load is placed on one side of the platform at one level and unloaded to the right or left (90 degrees) at another level. The last most common is the “C” pattern where the load is placed on and removed from the same side of the platform at each level. It is also possible to have a combination of load patterns on multiple level or special applications.

In some very special applications it may require 3-way or 4-way loading and unloading but these are rare and require special designed platforms. Depending on where the VRC is located, the size and types of loads being handled and the traffic pattern, additional guarding such as Back Stop Panels may be required adjacent to the platform to prevent personnel and/or loads from falling to the lower level.

After the traffic pattern has been determined the VRC platform type can be determined. See the following application table.

<b>VRC Design Configuration</b>	<b>Z</b>	<b>C</b>	<b>90°</b>	<b>3 Way</b>	<b>4 Way</b>
<b>Straddle</b>	✓	✓		✓	
<b>Cantilever</b>	✓	✓	✓	✓	✓
<b>Four Post</b>	✓	✓	✓	✓	✓
<b>Double Mast</b>	✓	✓		✓	

## 5.5 Loading and Unloading Methods

Consideration of the loading and unloading methods must be given when specifying a VRC as it may affect the design of the platform and the capacity of the unit. For instance, loading with a hand operated pallet jack may not require the same type of platform construction and unit capacity as loading with a powered pallet jack. Also, loading with a powered fork truck may not be allowed at either level depending on the VRC design specified, unless the specification explicitly calls for fork truck roll-over capacity and it is designated at which elevation or level a fork lift truck will be used. Note: This is true only in those applications where the fork truck must enter a platform in order to place the load. If the fork truck merely places the load on the platform without traveling onto the platform surface, then a standard VRC should handle the application, in which case restraints, curbs or a barrier should be provided to prevent fork truck entry onto the platform. Consideration should also be given to loads that may place a concentrated load on the platform and/or may not be on the platform's load center. Most VRC manufacturers assume uniform loading over the entire platform surface. Wheeled carts or trucks and pallet jacks are prime examples of this type of loading. When a VRC is used in an automated system with powered conveyor mounted on the platform, the reactionary forces of the load starting and stopping should be anticipated and proper

supports incorporated into the installation design. It should also be noted that turntables and pushers should be given special consideration because of the abnormal forces they generate. When using hydraulically actuated VRCs in automated systems it may not be advisable to use an upper level as the “Home Position” unless special consideration is given to the hydraulic circuitry and/or automatic re-leveling control circuit design. Mechanical type VRCs are not subject to down drift as with hydraulic VRCs and therefore, should be the first consideration for automated system applications.

## **5.6 Platform Guarding and Accessories**

VRC platforms can be manufactured in an infinite number of configurations. The load to be transported, should be considered when determining the style, construction, height and type of guarding, and accessories that are selected and specified. The minimum guarding requirement to meet the safety standard is nominal 42” high handrails with mid-rail and 4” high kick-plate on the non-operating sides of the platform and a snap chain that is a minimum of 39” high at its lowest point, mounted across the loading or operating side(s).

In cases where the VRC is at the edge of mezzanine, in an oversized shaft way, or where a situation exists whereby personnel and/or a load could fall below while loading or unloading the platform at a particular level, a Back Stop Panel should be added. The Back Stop Panel should be as wide as the platform and a minimum of 42” tall. If higher or unstable loads will be handled the Back Stop Panel should be taller than 42”.

- 5.6.1** Depending on the type of load being conveyed fixed panels may be substituted for handrails on the non-operating sides of the platform. Fixed panels may be constructed of solid sheet or expanded metal panels may be preferred. Typically, these are minimum 48” high or higher depending on the type of loads.
- 5.6.2** Gates and enclosures are required in accordance with ASME/ANSI B20.1 (See section 10).
- 5.6.3** All gates, whether vertical acting, horizontal sliding, or swing gates, must be equipped with an interlock. (See section 2.20 for definition).
- 5.6.4** Drop bars or other devices mounted to the platform that lower to prevent rolling loads from moving off the platform during operation may be required.

**5.6.5** The safety of gravity or powered roller conveyor used in conjunction with VRCs must be considered. Many automated systems, using powered conveyor for loading/unloading, have different guarding requirements. Consult your VRC supplier.

## **5.7 Electrical Considerations and Areas of Use**

**5.7.1** Operating conditions such as outdoor, wash down area, airborne dust, oil mist, etc. must be considered.

**5.7.2** Area activities such as a large volume of fork truck or people traffic may require special protection considerations and/or key lock type controls for use only by authorized personnel.

## **5.8 Operational Considerations**

**5.8.1** The controls may be constant pressure type where the operator must hold the operating button until the lifting or lowering cycle has been completed.

**5.8.2** The controls may be momentary contact call/send type, which only require the operator to press the directional button momentarily, allowing the VRC to travel to the level the operator has chosen, automatically and stop at that floor level by means of an electrical switch or physical stop.

**5.8.3** When loading a VRC with a fork truck, a ceiling mounted pull cord type switch may be desirable to activate the VRC and/or powered access gate.

**5.8.4** In automated systems the control system may be operated by a computer.

## **5.9 Power Unit and Drive Types**

### **5.9.1 Hydraulically Driven**

Most VRCs fall into this class because of the overall lower cost to manufacture this type of lifting system. The principal employed by most VRC manufacturers for this style drive is to use a single acting hydraulic cylinder and multiply its available stroke by means of a multiple cable or chain system. The advantage of this type of system is that it is economical and efficient but the travel height is limited. Another economical method incorporates a cylinder or ram acting directly on the VRC platform to raise and lower the load. The vertical travel is a 1 to 1 ratio of cylinder stroke to travel.

Lowering of the platform is strictly a function of gravity when the holding valve is opened allowing hydraulic fluid to drain back to the reservoir and lowering speed is controlled by a flow control valve.

Hydraulic VRCs are typically designed for 2 level operations. They are not recommended for applications with intermediate stops. Unless the unit is equipped with a positive stop or level-locking device the hydraulic control system will not provide accurate stopping position repeatability under both loaded and unloaded conditions.

### **5.9.2 Mechanically Driven**

This is the unit of choice for higher travel 2 level applications, 3 or more levels of operation where intermediate stops are required, automated system applications, and high speed or high cycle projects. This system utilizes an electric brake motor with a gear reducer. The carriage is typically raised or lowered by means of a heavy-duty chain(s). Travel is controlled with an electrical limit switch or similar device at each level. Stopping accuracy is normally good in loaded and unloaded conditions

### **5.9.3 Sizing a Drive or Power Unit**

A VRC unit should be sized to easily handle its rated working capacity, the lifting speed, and its duty cycle. Include weight of platform-mounted accessories when specifying the rated capacity.

Particular attention should be given to hydraulic units operating in abnormally high or low ambient temperatures as oil temperature could affect performance.

### **5.9.4 Locating a Drive or Power Unit**

Most manufacturers offer a standard remote mounted hydraulic power unit. The power units are typically designed to be positioned at either the top or bottom level. Reasons for a remote power unit may be the area, which is classified as non-hazardous, or the ambient temperature may be better suited for hydraulic fluids, noise, to limit access, or simply for ease of maintenance.

A mechanical chain driven unit cannot have the power unit located remotely but the electrical control panel may be mounted remotely within reasonable proximity of the lift thus reducing costs if the operating area is classified as a hazardous area.

## 6 Installation Considerations

### 6.1 Installer Guidelines

Proper installation of VRCs is vital to the safety of the operators, the efficiency of the unit, and the ultimate satisfaction of the end user. These guidelines have been prepared to assist installers in understanding their role and responsibility in providing customers with a safe and reliable VRC.

#### 6.1.1 Pre-Installation Activity

- 6.1.1.1 **Pre-Installation Visit:** Whenever possible, make a pre-installation visit or call someone at the site. Installers must be familiar with everything relative to proper installation of this equipment. It is the installer's responsibility to check the site for problems and work out solutions with the appropriate people – preferably before installation begins.
- 6.1.1.2 **Floor-to-Floor:** Check floor-to-floor dimensions on the general arrangement drawings to make sure that they match on-site conditions. VRCs are designed and built to individual applications and specific customer requirements. It is difficult and expensive to modify the lift after it arrives for installation.
- 6.1.1.3 **Scope of Work:** Installation may or may not include unloading, permits, seismic calculations, or extensive acceptance testing. The requirements of each contract should be carefully reviewed for possible conflicts of interpretation.
- 6.1.1.4 **Codes:** Each state, county, or municipality may have unique codes governing the installation and acceptance of VRCs. Acquaint yourself with the permitting and/or licensing requirements (and expenses) of the local regulatory agencies. Note also that some agencies may require inspection or testing before and/or after lift start-up.
- 6.1.1.5 **Ingress & Egress:** Make sure there is adequate ingress/egress to the installation site. Verify that the equipment can get through the existing doorways, halls, and shaft openings. Think through how the lift will be unloaded, carted/moved, raised into position, and accessed for installation, operation & maintenance.
- 6.1.1.6 **Structural Integrity:** Verify the construction and integrity of building columns, joists, walls, or mezzanines that will be used to help support the VRC mast guide beams.

## 6.1.2 Shipment & Initial Inspection

**6.1.2.1 Check for Damage:** Upon receipt of the shipment, check for exposed damage or shortages and make note of it on receiving paperwork from the trucking company, any claims for damage must be filed with the carrier. Unless otherwise stated, the VRC Manufacturer is not responsible for parts lost, stolen or damaged during transportation, storage, or installation.

**6.1.2.2 Check Packing List:** Assuming no damage has occurred to the crate, check the components against the packing list. This will provide assurance that every item shipped has been received.

**6.1.2.3 General Arrangement Drawings:** Make sure you have a copy of the latest version of the general arrangement and electrical drawings before beginning installation, changes could have been made since original purchase order submittal and order entry.

**6.1.2.4 Manuals:** Read and understand the Installation & Service manual thoroughly prior to starting the installation.

## 6.1.3 Equipment Layout

**6.1.3.1 Ensure Clearances:** Make sure pit and/or lift are properly squared and vertically aligned with upper landings to ensure that the carriage will clear the upper landings by the required distance.

**6.1.3.2 Building Obstructions:** Be sure to take into consideration any other obstructions (pipes, ductwork, ceiling joists/beams, etc.) that may be located around the lift.

**6.1.3.3 Overhanging Landings:** Inspect the installation for any overhanging floor landing or other obstruction (pipes, ductwork, ceiling joists/beams, etc.) which could potentially jam a load that is slightly overhanging the carriage deck as it raises to the next floor level. Any potential jam point should have some type of slanted or beveled guarding placed beneath the obstruction to push the overhanging load back onto the carriage.

## 6.1.4 Structural Installation

**6.1.4.1 Bracing:** Follow the bracing recommendations shown on the general arrangement drawings and in the Installation & Service manual. Site conditions may also require customization to standard anchoring and bracing. The installers are ultimately responsible for the proper and safe anchoring and bracing of the equipment and should consult the

manufacturer if there is any doubt as to the structural integrity of the installation.

- 6.1.4.2 Anchoring:** When anchoring guide beams to walls, you must be sure that the walls can support the reaction loads imparted on them.
- 6.1.4.3 Spliced Masts:** If spliced masts are provided, be sure to assemble and field install them exactly to the Manufacturer's recommendations. Failure to do so will reduce the safety and performance of the VRC.
- 6.1.4.4 Mast Positioning:** Make sure guide beam pairs are plumb, parallel, and straight after you are finished with all welding.
- 6.1.4.5 Lift Modifications:** Do not modify any component of the lift without expressed written consent from the Manufacturer.
- 6.1.5 Mechanical Lift Installation**
  - 6.1.5.1 Lift Blocking:** Most work can be done with the lift carriage fully lowered. Never work under the lift carriage unless it is blocked in place per the Installation and Service manual.
  - 6.1.5.2 No Riders:** Never allow a person to ride on the carriage of the lift.
  - 6.1.5.3 Hardware:** Use only the hardware supplied by the Manufacturer to assemble the lift. This hardware is often high grade, some hardware is metric.
  - 6.1.5.4 Motor Brake:** Do not remove or disconnect the motor brake on mechanical drives unless carriage and lifting chains are secured and properly supported.
  - 6.1.5.5 Lubrication:** Check gearbox fluid levels before starting up mechanical drive units. Failure to do so will reduce the effectiveness and safety of the lift.
  - 6.1.5.6 Lifting:** Use only the carriage lifting cables or chains and attachment hardware supplied by the Manufacturer.
- 6.1.6 Hydraulic Lift Installation**
  - 6.1.6.1 Lift Blocking:** Most work can be done with the lift carriage fully lowered. Never work under the lift carriage unless it is blocked in place per the Installation and Service manual.

- 6.1.6.2 Threaded Connections:** Never use Teflon tape on threaded connections. Teflon tape does not dissolve and, if introduced into hydraulic system, may contaminate the oil and cause valving to malfunction.
- 6.1.6.3 Relief Valves:** Never adjust a relief valve setting, these are factory set to meet design and code requirements.
- 6.1.6.4 Air Entrapment:** Carefully bleed all air out of the hydraulic system before running lift to full travel per Manufacturer's procedure in the Installation and Service manual.
- 6.1.6.5 Oil Level:** Make sure that the oil level in the reservoir is sufficient for running lift to full travel.
- 6.1.6.6 Approved Fluids:** Use only hydraulic fluid recommended by the Manufacturer in the Installation and Service manual.
- 6.1.6.7 Safety:** Make sure all pressure in the system is relieved before cracking open or disassembling any pressurized fitting or hose.
- 6.1.7 Electrical Installation**
  - 6.1.7.1 Voltage Ratings:** Ensure that the supplied voltage matches the motor supplied.
  - 6.1.7.2 Main Disconnect:** Make sure the customer-supplied electrical disconnect is installed and adequately fused.
  - 6.1.7.3 Codes:** All electrical work must meet the requirements of ASME B20.1 as well as all state and local codes.
  - 6.1.7.4 Qualification:** Make sure that only qualified electricians perform all wiring and that they are familiar with the electrical drawings shipped with the equipment.
  - 6.1.7.5 Avoid Binding:** Do not operate the lift until the carriage is leveled and the guide beams are plumbed and secure.
  - 6.1.7.6 "Manualling" Controls:** Never operate the lift by "Manualling" the electrical controls (using the contactors located inside the control panel). All safety devices are by-passed in this mode of operation and lift damage or severe personal injury could occur.

- 6.1.7.7 Safety Devices:** Do not operate the lift using the operator pushbuttons prior to having all safety devices and/or gate interlocks wired and in the circuit. Never by-pass any safety device and/or interlock.
- 6.1.7.8 Brake Wiring:** Electrician should ensure that motor brake wiring is complete when wiring the motor.
- 6.1.7.9 Operator Station Location:** Operator pushbutton stations must not be operable from the carriage with the gate(s) or door(s) closed, or must be located at least 6 feet away from the carriage platform.
- 6.1.7.10 Control Panel:** Per OSHA requirements, the control panel must be mounted in a location that is visible from the lift.
- 6.1.7.11 Electrical Safety:** Always follow OSHA lock-out, tag-out procedures when the lift being maintained, serviced, or inspected.

## **6.1.8 Personnel & Equipment Safeties**

- 6.1.8.1 Gates & Enclosures:** ASME B20.1 requires that all VRC installations be completely guarded to prevent injury from inadvertent contact with the lift or its load. ASME also requires that doors or gates at all unloading stations be interlocked so that these doors can only be opened when the lift carriage is stopped at that level & that the carriage is incapable of being operated or moved so long as these doors or gates remain open. It is the responsibility of the installer to ensure that the installation meet these requirements, regardless of who (manufacturer, customer, architect, general contractor, etc.) provides the doors/gates and means of enclosure. Consult the manufacturer whenever there is a question as to whether or not the gate & enclosure installation meets ASME B20.1.
- 6.1.8.2 Carriage Guarding:** Where the application requires personnel to walk onto the carriage in the raised position, the installer must ensure that the carriage is adequately provided with railings, guards, and snap chains that are a minimum of 42" high.
- 6.1.8.3 Sensors & Switches:** Travel limit switches, slack chain or cable sensors, and over travel sensors (for mechanical units) must be installed and working properly.
- 6.1.8.4 Motor Brake:** Ensure proper operation and engagement of motor and carriage brake assemblies.

## 6.1.9 Testing

**6.1.9.1 Speeds:** Test up and down speeds.

**6.1.9.2 Sensors & Switches:** Test all limiting devices, gate interlocks, gate status switches, sensors, and any other safety features or devices as outlined by the Installation and Service manual.

**6.1.9.3 Other Testing:** Some states or municipalities may require testing of the carriage free-fall arrest system (carriage brakes, slack chain/cable brakes, etc.) – consult the manufacturer.

## 6.1.10 Clean-up & Hand-off

**6.1.10.1 Sensors & Switches:** Ensure that all necessary adjustments to the interlocks, gate status switches, upper & lower lift status limit switches allow proper operation of the lift and its safeties per the manufacturer's requirements.

**6.1.10.2 Signage:** Apply proper signage to all locations of the installation per the guidelines in the Installation and Service manual. Consult the manufacturer if labels appear to be missing or damaged.

**6.1.10.3 Housekeeping:** Clean up any spilled oil from the area.

**6.1.10.4 Training:** Train key personnel on the operation of the system and all safety features and procedures.

## 6.2 Surface Mounted Lifts

**6.2.1** Floor anchors should be suitable for the floor condition and thickness and meet the manufacturer's requirements for pull strength.

**6.2.2** If loading is by other than a counter-balanced fork lift truck, conveyor or by hand, then a ramp may be necessary. Typically there are two types of ramps; a fixed ramp mounted to the floor on the loading side of the platform or a hinge mounted to the platform. If a hinged ramp is considered then the following should be given some thought.

The ramp will have to be raised and lowered for loading.

An electrical interlock should be used on the ramp to ensure that it is in the raised position before operating the VRC.

If traveling through a hole at the upper level, it may have to be larger to accommodate the ramp, and it may interfere with loading at the upper

level. Note: The rule of thumb for length of the incline is 12" of length for each 1" of rise.

For fork truck loading a curb on the landing should be considered for the loading side in order to protect the VRC platform from damage by the fork truck.

### **6.3 Pit Mounted Lifts**

**6.3.1** VRCs may be pit mounted with the entire structure including the mast or guide beams and the platform in the pit. However, straddle and four post designs allow pit mounting of the platform only with the mast or guide beams mounted to the floor surface and only the platform in the pit in the lowered position. The advantage of this style is the thickness of the floor will carry the load and will normally not require additional footings. Consult your architect before making this assumption

**6.3.2** If the entire unit including the mast and platform will reside in the pit, the pit should be sized to accept those components with adequate clearances provided. The manufacturer will normally supply a recommended pit drawing. A normal platform running clearance on the loading side(s) would be 1" maximum and ½" minimum.

**6.3.3** The pit floor should have proper drainage and sufficient strength.

**6.3.4** The pit depth should be such that it will allow shimming of the VRC to bring the platform top surface flush with the floor.

### **6.4 Mast or Guide Beam Support**

**6.4.1** Most cantilever type VRCs will require the masts to be tied in to the building structure at the upper level and/or at intermediate levels to prevent platform sway caused by the reaction forces of loading and unloading operations at the upper levels.

**6.4.2** Some double mast and four post configurations may be designed to be completely free standing and may not require external support. Most VRCs require some support or stabilization from the building structure; the VRC manufacturer will provide the requirements for their particular VRC model.

Note: In some areas seismic calculations may also be required prior to the installation of a VRC. Check your local and state requirements for criteria regarding the extent of these calculations and the qualifications required by the engineer who performs them.

## **6.5 Floor Opening and Mezzanines**

Floor hole sizes and edge of mezzanine clearance should be per manufacturer's recommendations.

Where it is not possible to maintain the manufacturer's recommended clearances a throw-over plate may need to be added to the edge of the VRC platform or if possible, build out the edge of the landing to ensure safe loading and unloading. If large openings exist it may be necessary to provide additional guarding for personnel safety

## **7 Electrical Considerations**

- 7.1** Adequate power must be available to the location of the lift. Typically, the customer must provide the providing adequate power to within ten (10) feet of the lift.
- 7.2** A fused disconnect typically is required and is not typically provided as standard equipment by the VRC manufacturer.
- 7.3** Application specific conditions and hazards determine the electrical classification or NEMA rating of the area such as NEMA 1, NEMA 4 for washdown, NEMA 7 or 9 for hazardous environments, etc.

## **8 Wiring Considerations**

- 8.1** Many parts of the VRC are prewired by the manufacturer, but there can be considerable field wiring.
- 8.2** All wiring must be accordance with The National Electric Code and/or any applicable local code requirements.

## **9 Power Unit Considerations**

- 9.1** Hydraulic power units can be mounted on or near the mast. Typically, they should be within thirty (30) feet of the VRC. Hydraulic units typically develop little heat under normal operating conditions and can be placed in confined areas such as under stairwells provided they are accessible for maintenance.
- 9.2** Mechanical power units or drives are typically mounted at the top of the mast or guide beams. Since these units require little service catwalks and/or maintenance ladders are not required.

## **10 Safety Gate and Enclosure Considerations**

### **10.1 Basic Requirements**

- 10.1.1 ASME/ANSI B20.1** requires 96” high enclosures at each floor level with the exception of the top floor or landing which in some cases may be permissible to use 42” high handrails as a portion of the guarding.

Enclosures may be fabricated from woven wire, expanded metal, sheet metal, studded wall (wood or steel), or cement block. Wire or metal mesh must have openings small enough to reject a 2” ball. All enclosures must be able to withstand 100 pounds of force in any direction.

Types of loads and internal company safety standards may determine the type and height of enclosures to be used. For example, a VRC carrying small loose boxes would be considered safer if it were enclosed the full height between floor levels and to a height of 84” above the upper floor level service.

The location of a VRC will also determine the type and size of an enclosure. It may be advantageous to locate the VRC alongside a wall or in a corner thus reducing the size of the enclosure required to safely enclose the VRC.

The positioning of the enclosure in relationship to the VRC is important. The distance between the inside of the enclosure and the extremities of the VRC normally should be kept to a minimum to reduce the possibility of a person from being positioned between the enclosure and the VRC.”

### **10.2 Safety Gate Types**

Many manufacturers offer special gates not listed. Consult the VRC manufacturer. Note: Gates do not take the place of fire doors where required.

### 10.2.1 Single Swing Type Gate

This type of gate hinges on one side and latches on the other, may be either right or left-hand swing. Probably the most common type in use, but the clear opening width is limited normally to approximately 60" to 72" maximum and requires clear space in front of the lift to swing open. Typical swing gate height is 84" but may be raised or lowered to accommodate load height requirements or to allow support between adjacent enclosure panels or walls.

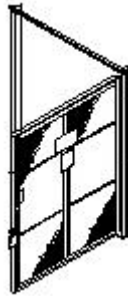

### 10.2.2 Bi-parting, Double Swing Type Gates

This type of gate hinges on each side and latches in the center. This style of gate may be used for openings greater than 60" but usually not exceeding 120" in width.

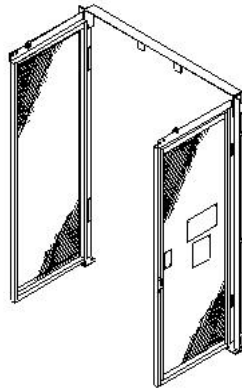

### 10.2.3 Single Panel, Counter-balanced Vertical Rising Gate Assembly

This type of gate closes to the floor and opens in the upward direction. This style of gate can be constructed to handle gate openings up to 16' wide. Though they are normally either 72" or 96" high they can be made higher, however, the drawback being vertical rising gates need a vertical guide track which will be at least twice the height of the gate panel. This style gate may not be feasible in an installation where loading is on the same side two consecutive floors.

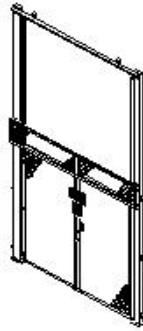

### 10.2.4 Double Panel, Counter-balanced, Vertical Rising Gate Assembly

This type of gate is the same as the single panel, counter-balanced vertical rising gate assembly above in operation and use except the two (2) panels telescope from a nested position which only requires about 75% as much overall height.

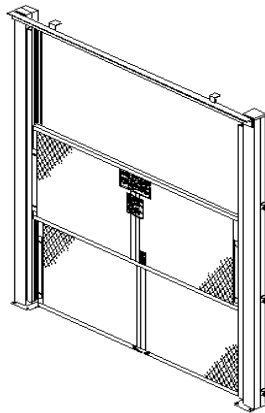

### 10.2.5 Horizontal Sliding Type Gate Assembly

This style gate operates in the same matter as a vertical rising gate assembly except it functions in the horizontal direction and requires considerable storage room on one side when open. Another disadvantage of this type of gate is that it requires an overhead track above the gate opening.

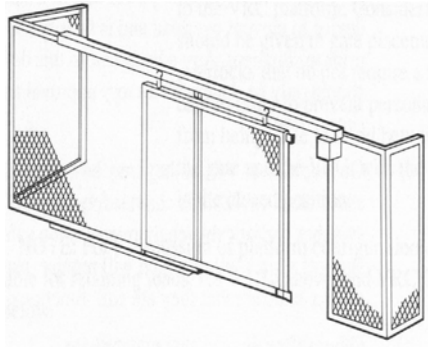

### 10.2.6 Roll-up Type Door Assembly

This style gate can be anything from an industrial type roll-up steel door to self-storage facility type door. This style gate has an advantage in that the gate itself does not require a lot of space. Some disadvantages are that it is slow in operation, may require considerable maintenance, and it is mounted over the gate opening and may limit the load height. It may be of the manual or powered variety.

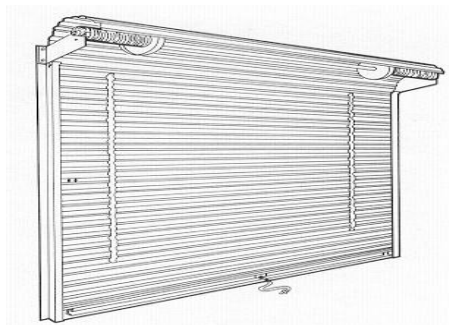

All of the above gates must be equipped with an electro-mechanical interlock system to meet the code requirement. The purpose is to discourage people from riding the carrier or carriage and to help provide a guarded opening at any landing. The locking component of the interlock system is designed to lock the gate or door in the closed position whenever the lift carrier or carriage is not present at that particular opening. The gate status component is intended to prevent operation of the VRC unless all gates are closed.

## **10.3 Gate Interlocks – General**

Regardless of the gate or door type, all access gates must be equipped with an electromechanical interlock system to meet the code requirement and to provide a safe operating environment. The purpose of the interlocking system is to help prevent the occurrence of an unintentional or unguarded gate/door from opening at a landing level when the carrier or carriage is not present at that level and to help prevent people from being able to ride on the VRC carrier or carriage.

There are two (2) primary elements common to any code compliant interlocking system; a mechanical locking component and a status-sensing component. The locking component can be either electrically or mechanically actuated and is designed to mechanically lock the gate or door in the closed position whenever the lift carrier or carriage is not present at that particular landing. The gate status switch component is intended to provide an electrical signal to the control panel that will prevent the operation of the VRC unless all gates are fully closed.

### **10.3.1 Mechanically Actuated Interlocks**

Mechanical interlocks are devices that normally integrate both the locking and status sensing components of the interlock system in a single housing. This type of interlock provides a mechanical actuation of a mechanical locking device and is typically mounted to a permanent structure just inside the gate and adjacent to the landing position of the carrier or carriage. This interlock receives a striker plate which is mounted to the gate/door panel from the top or side depending on the type of gate/door. This striker plate automatically captured mechanically when the lift leaves the landing and automatically and mechanically opens or closes the electrical circuit to the motor starter with its presence or absence.

There are several advantages to this type of interlock system; 1) it is both a gate sensing and gate locking device, 2) it is difficult to tamper with or override, 3) it provides simple, durable, and reliable service in dirty or dusty environments, and 4) it requires close proximity to the lift carrier or carriage to be actuated by a cam on the lift which inherently creates less space between the gate/door and the for a person to stand while the gate is closed. A disadvantage is its bulky size which limits its use in applications calling for very tight running clearances such as shaft installations.

### **10.3.2 Electrically Actuated Interlocks**

Electrically actuated or solenoid interlocks are devices that normally provide only the locking element of the interlock system. A separate set of electrical switches typically must be installed to provide status sensing of the gates/door. This type of interlock provides an electrical actuation of a mechanical locking device and is typically mounted to the gate post frame or header. The mechanical device/plunger is installed in such a way as to capture the gate(s)/doors(s) when closed and actuates immediately after the lift carrier or carriage leaves the landing. The separate gate status switches are installed in the same vicinity as the solenoid interlock and open or close the electrical circuit to the motor starter with the gate/door's status of being either open or closed.

The advantages to this type of interlock system are: 1) it is easier to position and install, 2) it is typically less expensive to purchase, and 3) it is small, compact and fits well into cramped environments with tight running clearances such as shaft ways. Disadvantages to the solenoid interlock system are: 1) its sensitive design which makes it less suitable for dirty or dusty environments, 2) it requires the addition of gate status switches to perform to code, and 3) the interlock and status switches are more easily tampered with or overridden because they are typically not well guarded and installed on gate/frames which are more easily accessible to non-maintenance personnel.

### **10.4 Back Stop Panel**

Back Stop Panels should be used at upper levels, where necessary, to prevent personnel and/or loads from falling to the lower level. The position of the Back Stop Panel in relationship to the platform should allow for the vertical movement of the platform to easily pass the fixed Back Stop Panel. It should be at least as wide as the platform and close enough to minimize what could potentially fall off the edge of the platform during loading. A typical distance between the edge of the platform and the Back Stop Panel is 2 inches. Back Stop Panels should be constructed of rigid material able to withstand a lateral force of 100 lbs. at any point, a load of 200 pounds applied in any direction and be able to reject a 2" diameter ball.

## 11 Labeling

### 11.1 Minimum Recommended Labels

The following illustrations describe minimum recommended labels and their locations for all VRCs. See figure 11 for locations of the signs. This signage follows ANSI standard Z535.4 – Product Safety Signs and Labels.

- 11.1.2 It is recommended that nine (9) different signs be used in various locations on the VRC as illustrated.
- 11.1.3 Signs #1, #3, #4, #5, #6, #7 and #8 are warning signs and therefore are orange. Sign #2 and #9 are danger signs and are therefore red.
- 11.1.4 Sign #1 should be approximately 7" x 8-5/8" and reads: *Warning— only trained persons shall be permitted to operate or maintain this equipment. Improper operation or maintenance may cause serious injury or death. Review operations manual before use.*

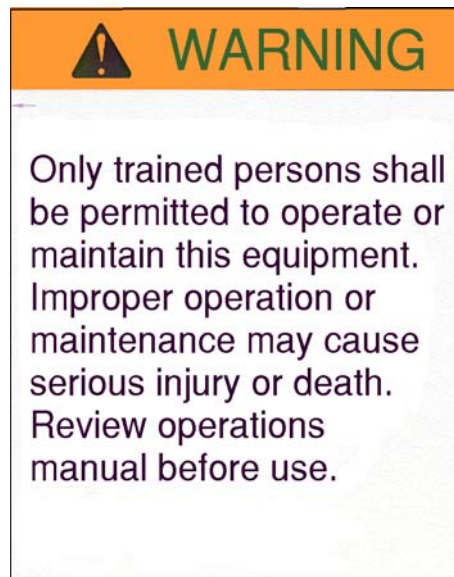

(SIGNAGE LOCATION - Located on all gates or doors leading into the carriage.)

- 11.1.5** Sign #2 should be approximately 2-1/2" x 5-1/4" and reads: *Danger — This door must be closed and locked unless carrier is present.*

*Door interlock must be operational. It prevents door from being opened when carrier is not present.*

*Door restricts personnel from falling into opening or being struck by moving parts resulting in serious injury or death.*

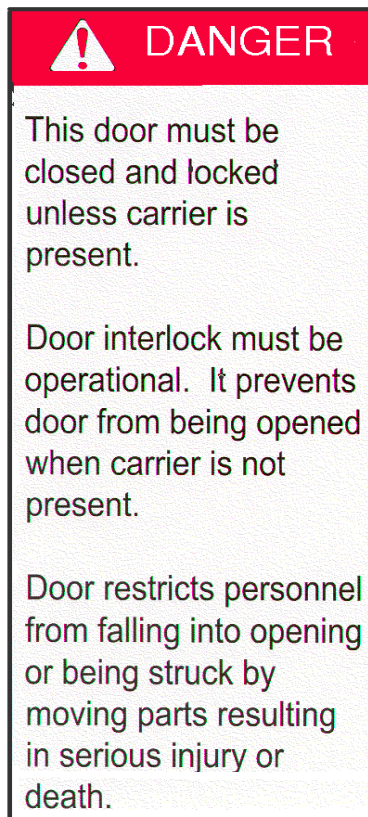

(SIGNAGE LOCATION - Located on or near the gate or door handle or mid-height on vertically sliding doors.)

- 11.1.6** Sign #3 should be approximately 7/8" x 2-1/8". It reads: *Warning: Do not allow riders.*



(SIGNAGE LOCATION - Located on all pushbutton stations.)

- 11.1.7 Sign #4 should be approximately 3-1/2" x 10" and read: *Warning: No Riders.*



(SIGNAGE LOCATION - Located side or over head panels where they would be obvious to personnel entering or leaving the carriage.)

- 11.1.8 Sign #5 is 7-3/4" x 12-7/8" and reads: *Do not ride on this equipment. Personnel safeguards are not provided and serious injury or death could result.*

This sign also has a "no personnel" symbol on it.



(SIGNAGE LOCATION - Located on the outside of all gates at eye level.)

- 11.1.9 Sign #6 is 5" x 5" and reads: *Warning – Do not disassemble motor/gear box or drive chain, or adjust brake without first securing platform.*

*Disassembly or adjustment allows platform, and/or chains to freefall if not secured.*

*Consult service manual before proceeding.*

*Failure to follow these instructions can cause severe personal injury or death.*



(SIGNAGE LOCATION - Located on Gear Motor or drive base for all Mechanical VRCs.)

- 11.1.10 Sign #7 is 2" x 6" and reads: *Warning – Do not operate without carriage personnel guarding. Serious injury or death could result.*



(SIGNAGE LOCATION - Located on all carriage handrails and/or side guards.)

- 11.1.11 Sign #8 is 1" x 2" and reads: *Warning – Do not tamper or interfere with this device. Serious injury can result.*



(SIGNAGE LOCATION - Located adjacent to all limit switches, status switches, sensing switches and interlocks.)

- 11.1.12 Sign #9 is 3" wide x 6" high (or alternately 6" wide x 3" high). This is a combination label that warns of the dangers of a shock hazard as well as the possibility of arc flash.

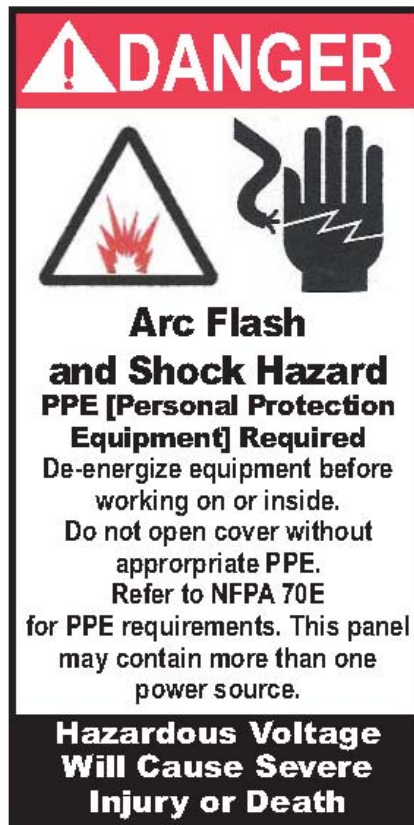

(SIGNAGE LOCATION - Located on the outside cover of any electrical enclosure containing contact devices (i.e., motor starters, controllers, disconnects, etc.)

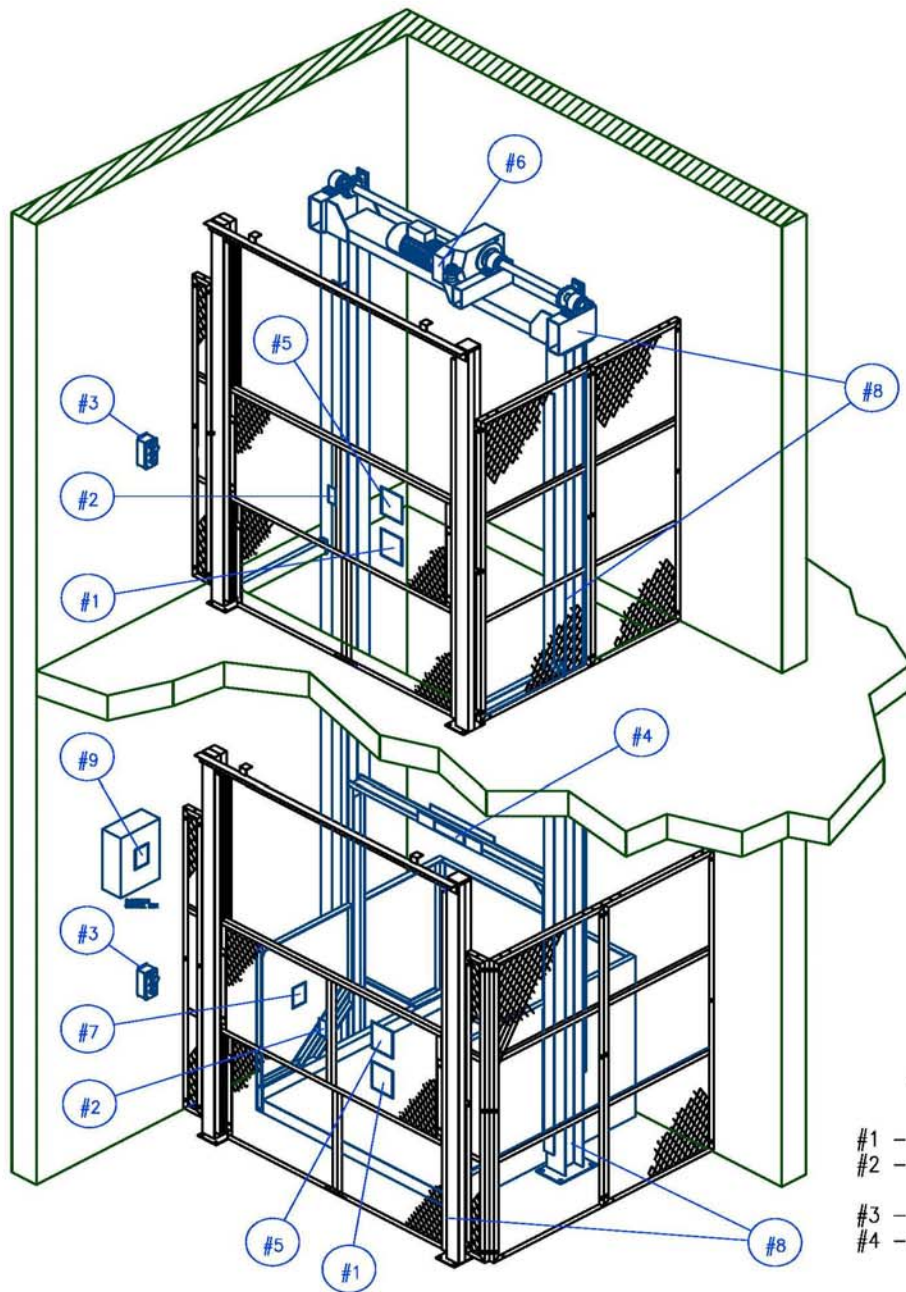

## SIGNAGE LOCATIONS

- #1 - ON ALL DOORS AT EYE LEVEL.
- #2 - NEAR DOOR HANDLE OR MID-HEIGHT OF SLIDE-UP DOOR, ALL DOORS.
- #3 - ON ALL PUSHBUTTON STATIONS.
- #4 - ON BOTH SIDES OF CARRIAGE AND/OR OVERHEAD - OBVIOUS WHEN ENTERING OR LEAVING THE CARRIAGE.
- #5 - LOCATED ON THE OUTSIDE OF ALL GATES OR DOORS.
- #6 - ON GEAR MOTOR OR DRIVE BASE.
- #7 - LOCATED ON THE HANDRAILS OR SIDE PANELS OF THE CARRIAGE.
- #8 - LOCATED NEAR ALL LIMIT OR PROXIMITY SENSING AND INTERLOCK SWITCHES.
- #9 - LOCATED ON THE OUTSIDE COVER OF ELECTRICAL CONTROL PANELS WHICH CONTAIN CONTACT DEVICES.

**Figure 11**

## 12 Maintenance Considerations

Only authorized personnel should perform inspection or maintenance and service procedures. Unauthorized personnel attempting maintenance procedures do so at the risk of personal injury or death.

Always contact the factory for assistance whenever it is perceived that normal maintenance procedures cannot be followed.

### 12.1 Safe Blocking Instructions

Failure to properly adhere to lift blocking procedures is to risk the sudden and uncontrolled descent of the lift during maintenance or inspection. A falling lift can cause severe injury or death. Follow the manufacturer's lift blocking instructions EVERY time you plan to reach or enter bodily beneath the lift to perform service or maintenance – no matter how momentary that might be.

If the maintenance device(s) are damaged or missing, stop immediately and contact the factory for assistance. The manufacturers can not foresee, and are not liable for, failure to use the approved maintenance device(s) and procedures that have been provided.

### 12.2 Achieving Maintenance Position

Never go under an unsupported platform! To avoid personal injury or death, always be sure the load has been removed from the platform and that it has been blocked adequately to prevent shifting or dropping unexpectedly!

If Not Operational: The carriage **MUST** be blocked adequately from beneath until the time that the lift is made operational again.

#### 12.2.1 Fully Lowered Carriage

The safest way to inspect or maintain a VRC unit is with the load removed and the lift carriage in the fully lowered position. When the carriage is fully lowered it has no potential to suddenly or unexpectedly shift or drop.

If the lift carriage cannot be lowered normally, contact the factory for assistance. If stalled or stuck, the carriage should be secured at its stuck position before attempting to walk on or under the platform.

### **12.2.2 Raised Carriage**

All loads must be removed from the lift platform prior to engaging the maintenance devices. These devices are designed to support an unloaded carriage only. Failure to remove the load from the platform prior to blocking could cause the failure of the maintenance devices and allow the lift to fall unexpectedly.

Raise the carriage to the desired elevation by pressing the UP button, and then press the EMERGENCY STOP button when the desired height is reached.

### **12.3 Placement of Maintenance Devices**

Depending on the size of the carriage, insert an adequate number of sound and stable supports of equal length beneath the lift carriage in order to create a stable and crush-proof support system. Be sure that the supports cannot move or shift during maintenance or inspection, also remove any debris that may interfere with the bottom of the supports.

You should not stand beneath the carriage while setting the maintenance devices into position. To avoid personal injury or death, check the stability of the supports. If there is any chance of the support tipping or otherwise not providing a safe and stable condition, do not go under the carriage!

### **12.4 Blocking the Carriage**

Lower the carriage onto the maintenance devices. Re-check to ensure that all devices are fully and properly engaged with the underside of the carriage. If all maintenance devices are not fully engaged the carriage could fall unexpectedly, resulting in permanent damage to the devices or the lift.

Once inspection or work is complete, raise the platform off the maintenance device(s) and return the device(s) to their designated storage positions.

#### **12.4.1 Hydraulic Units**

Either press the DOWN button or open the manual lowering valve until the carriage lands onto, and is fully supported by, the maintenance devices. Once the carriage lands, continue to hold the DOWN button/lowering valve for an additional 5-10 seconds to relieve the hydraulic system of pressure.

#### **12.4.2 Mechanical Units**

Press the DOWN button until the carriage lands onto, and is fully supported by, the maintenance devices. If the slack chain sensors do not turn the motor off, press the EMERGENCY STOP button.

#### **12.5 Electrical Safety**

Follow OSHA electrical lock-out/tag-out procedures before performing service or maintenance. Disconnect and tag all electrical and/or other power sources to prevent an unplanned or unexpected actuation of the lift.

#### **12.6 Specific to Mechanical Lifts**

Extreme caution must be taken anytime the gearbox or brake motor is released via the manual brake release handle or if it is disassembled. All holding and braking forces on the lifting chains are removed and the chains are allowed to “free-wheel” under their own weight or any other weight that may be on the chains, including the weight of the carriage, allowing the carriage to fall uncontrollably and cause serious injury or death.

Therefore, any time maintenance to the drive assembly is performed utilizing the lift platform as the work platform, the carriage MUST be blocked adequately from beneath or properly secured to the drive base structure above with (1) primary and (1) redundant/back-up system of chains or straps of sufficient capacity. Contact the factory for assistance any time this is done.

Only trained and qualified technicians should operate the manual brake release (when provided). With the brake disengaged, the carriage could fall uncontrollably and cause serious injury or death.

#### **12.7 Specific to Hydraulic Lifts**

Failure to relieve operating system pressure could result in the sudden and unexpected release of high-pressure fluids during maintenance and/or repair of the lift which may result in severe injury or death.

#### **12.8 General Maintenance**

The following are general guidelines. Always refer to manufacturer’s owner’s manual.

- 12.8.1 Maintenance, such as lubrication and adjustment, shall be performed by qualified and trained personnel.
- 12.8.2 Lack of maintenance may cause a hazardous condition, the user shall establish a maintenance program to ensure that VRC components are maintained in a condition that does not constitute a hazard to personnel (see owner's manual).
- 12.8.3 No maintenance, or lubrication, shall be performed when the VRC is in operation. Most VRCs are serviced with the carrier or carriage lowered. Consult manufacturer's service instructions.
- 12.8.4 When the VRC is stopped for maintenance or repair purposes, the main power shall be locked or tagged out in accordance with a formalized procedure designed to protect all persons or groups involved with the VRC against an unexpected restart.
- 12.8.5 All safety devices and guards shall be replaced before starting equipment for normal operation.
- 12.8.6 Routine inspection and corrective maintenance measures shall be conducted to ensure that all guards and safety features are in place and function properly.
- 12.9 **Hydraulically Actuated VRC**
  - 12.9.1 Check hydraulic fluid level and fluid contamination.
  - 12.9.2 Check hydraulic fitting leakage.
  - 12.9.3 Check hydraulic cylinder seals
- 12.10 **Mechanically Actuated VRC**
  - 12.10.1 Check fluid levels in gearboxes
  - 12.10.2 Grease pillow blocks per manufacturer's instructions.
  - 12.10.3 Inspect motor brake assembly, mechanical connections, such as sprockets to drive shafts, inc.
- 12.11 **VRC Lift System**
  - 12.11.1 VRC with lifting chains, check for chain stretch with chain gauge, check chain connections, and lubricate per manufacturer's instructions.

**12.11.2** VRC with cable lifting system, check for stretched or frayed cable(s) and replace. Check cable attachment, and inspect and lubricate cable sheaves per manufacturer's instructions.

**12.11.3** For a VRC with screw jack type lift system follow manufacturer's instructions for care and maintenance.

## **12.12 VRC Guide System**

**12.12.1** Check with VRC manufacturer, but in general the guide wheels, rollers, or slide mechanisms may need to be lubricated if not equipped with sealed bearings and the guide rails may require periodic greasing.

**12.12.2** Inspect rails for abnormal wear or deformation.

## **12.13 VRC Safety Devices**

**12.13.1** All VRCs on which the carrier or carriage is suspended must be equipped with a falling platform safety device(s). These devices may require periodic testing and lubrication depending on the manufacturer. Direct acting hydraulic ram or cylinder supported carriers or carriages do not require a falling platform safety device and should not be subject to any applicable drop test requirements. The manufacturer's instructions for these devices should be followed exactly.

**12.13.2** On hydraulic actuated VRCs, a relief valve is provided in the hydraulic power unit as a safety device to prevent overload and is factory set prior to shipment. Any adjustment to this device should only be done with factory approval and/or supervision.

**12.13.3** On mechanical VRCs, they may be equipped with either slack cable/slack chain safety shut off switches and/or cable/chain over-tension shut off switch, all of which will require periodic checks to make sure they are functional.

**12.13.4** Other safety devices that may require maintenance and checking if the VRC is so equipped, are any removable guard interlocks, gate electrical-mechanical interlocks, and over-travel limit switches. There may be other devices not mentioned. Check with the manufacturer of the VRC that you are considering.

## **13 Operation Considerations**

- 13.1** Only a trained person shall be permitted to operate the VRC. Training shall include instruction in operation under normal conditions and emergency situations.
- 13.2** No person shall ride on a VRC.
- 13.3** The VRC shall be used to transport only loads it is designed to handle safely.
- 13.4** The area around loading and unloading points shall be kept clear of obstructions that could endanger personnel or interfere with proper operation of the VRC.
- 13.5** Emergency stop buttons shall be kept free of obstructions to permit ready access.
- 13.6** Personnel working on or near the VRC shall be instructed as to the location and operation of the Emergency stop buttons.
- 13.7** Under no circumstances shall the limit switches, operating controls or safety devices of the VRC be altered or modified or their functionality defeated as such alterations would endanger personnel.

## **14 Start-up Testing**

- 14.1** Close all gates and doors.
- 14.2** Run the empty VRC carrier or carriage to each level.
- 14.3** Check that gates at all levels will not open if the lift is not present.
- 14.4** Check to ensure the lift will not operate if any gate is open.
- 14.5** Place a capacity load on the carrier or carriage and run the carrier or carriage to all levels. The carrier or carriage should stop at the proper elevation loaded and unloaded.
- 14.6** Allow the carrier or carriage to remain at the top level for 4 hours. Platform should not drift or leak oil.
- 14.7** Check to ensure the lift operates at the rated speed.
- 14.8** The VRC should function smoothly and relatively quietly. If the VRC does not function as stated in the owners manual or does not pass these tests, consult the manufacturer before putting the lift into service.
- 14.9** Check that each emergency stop button will stop the moving carrier or carriage. The carrier or carriage should not resume movement when the emergency stop button is returned to its normal position.